

TECHNICIAN'S
Low Profile Ion Pumps
(Flat Pole Pieces)
Component Manual

Part No. 638356 Rev. E

Copyright © 2000
Physical Electronics, Inc.
6509 Flying Cloud Drive
Eden Prairie, MN 55344

The PHI logo is a registered trademark of Physical Electronics, Inc. Physical Electronics, PHI,
and  are trademarks of Physical Electronics, Inc.

All other trademarks are the property of their respective owners.

PHI Safety Notices

Physical Electronics' (PHI's) products are designed and manufactured in compliance with accepted worldwide practices and standards to provide protection against electrical and mechanical hazards for the operator and the area surrounding the product. All PHI products are designed and intended for professional use only, by skilled "operators" for their intended purpose and according to all of the instructions, safety notices, and warnings provide by PHI.

Those instructions, notices, and warnings assume that an "operator" will not employ any tool when using PHI products. They further assume that all operators clearly understand that use of PHI products in any manner not specified by PHI may impair the protection provided by the products and expose them to hazards.

A "technician" is a qualified servicing individual who:

- Has received training to work with voltages above 50 V,
- Has read and understood the PHI technician's manual for the equipment,
- Observes and understands all safety notices on PHI equipment.

The safety symbols that PHI uses are defined on the following page.* To reduce or eliminate hazards, technicians and operators of this equipment must fully understand these symbols.

PHI's products are installed with international-style or ANSI†-style safety notices, according to site requirements. International notices are symbols within triangles (alerts) or circles (mandatory actions). PHI's ANSI-style safety notices contain:

- One of three signal words (in all capitals) preceded by the general danger symbol ();
- One of PHI's safety symbols along with a brief description of the hazard and the risk or injury that could occur;
- Short message that observes ANSI's Hazard Alert Trilogy Rule by identifying the hazard, the possible result of ignoring the notice, and how to avoid the hazard.

The three signal words are defined as follows:

- **DANGER**—imminently hazardous situation that, if not avoided, will result in death or serious injury;
- **WARNING**—potentially hazardous situation that, if not

avoided, could result in death or serious injury;

- **CAUTION**—potentially hazardous situation or unsafe practice that, if not avoided, may result in minor or moderate injury or damage to equipment.

SEMI‡ standards require identification of type 3, 4, and 5 electrical maintenance tasks in equipment manuals:

- **Type 3** electrical maintenance tasks involve energized equipment, exposed live circuits, and possible accidental contact; potential exposures are less than 30 V RMS, 42.2 V peak, 240 V-A, and 20 J.
- **Type 4** is the same but potential exposures are greater than 30 V RMS, 42.2 V peak, 240 V-A, and 20 J or radio frequency is present.
- **Type 5** tasks involve energized equipment and measurements and adjustment require physical entry into the equipment, or equipment configuration will not allow the use of clamp-on probes.

Only experienced, trained technicians should attempt to perform type 3, 4, or 5 electrical maintenance tasks.

* Many of PHI's safety symbols are provided and copyrighted by Hazard Communication Systems, Inc., Milford, PA.

† American National Standards Institute, 1430 Broadway, New York, NY 10018.

‡ Semiconductor Equipment and Materials International, 805 E. Middlefield Rd., Mountain View, CA 94043-4080.

PHI Safety Notices



Voltages may be present that could cause death or personal injury.



A risk of death, personal injury, and/or damage to equipment exists (and a more specific label is not available).



Pulling the plug from its power source before servicing is mandatory.



A pinching point is present that could cause personal injury.



A risk of explosion or implosion may be present that could cause personal injury.



Lifting with assistance or equipment could cause personal injury.



An overhead door is present that could cause personal injury. Do not work under door without auxiliary door supports installed.



Visible or invisible radiation may be present that could cause personal injury.



Hot surfaces may be present that could cause personal injury.



Turning off the power switch before servicing is mandatory.



Refer to the manual(s) before proceeding.



Contents are under pressure.



A harmful or irritant material may be present that could cause personal injury.



Extremely low temperatures may be present that could cause personal injury.



A risk of fire may be present that could cause personal injury.



A potentially dangerous magnetic field may be present.



An environment with depleted oxygen may be present that could cause death or personal injury. Open at least 2 doors and wait 2 minutes before entering the enclosure.



Wearing protective gloves is mandatory.



Wearing eye protection is mandatory.



Wearing foot protection is mandatory.



This is the location of the protective grounding conductor terminal.



This is the location of the fuse.



This is the location of an earth (ground) terminal.

Contents

PHI Safety Notices	iii
Limited Warranty.....	vii
Customer Service	viii
Preface	1
1: Specifications	1-1
Introduction	1-1
Low Profile Pump 100.....	1-2
Low Profile Pump 200.....	1-4
Low Profile Pump 300.....	1-6
Low Profile Pump 400 Stacked.....	1-8
Low Profile Pump 600 Stacked.....	1-10
Boostivac Pumping	1-13
2: Installation	2-1
Unpacking and Inspecting for Damage.....	2-2
Initial Checkout	2-2
Ion Pump Installation	2-2
Heater Installation.....	2-4
3: Operation	3-1
Pump Roughing	3-1
Pump Starting	3-2
Start Procedure with No Isolation Valve.....	3-2
Start Procedure with Isolation Valve	3-3
Ion Pump Operation.....	3-3
Boostivac Pump Operation	3-4
Up-to-Air Procedure.....	3-4
Bakeout.....	3-5

Contents

4: Service	4-1
Troubleshooting Ion Pumps	4-3
Vacuum Leak Testing	4-5
Operation Check of Ion Controller.....	4-5
Leakage Current and Field Emission Test	4-6
Resistance Check of Ion Pump Elements.....	4-7
Bakeout Operation Procedure.....	4-7
Magnet Orientation in Ion Pumps.....	4-8
Operating Pressure	4-9
Oxygen Process	4-9
Disassembling the Ion Pump	4-10
5: Replacement Parts and Accessories	5-1

Figures

2-1	Installation Connections for a Typical Vacuum System	2-2
2-2	Installing the Ion Pump	2-3
2-3	Heater Installation Diagram	2-4

Tables

1-1	Pump Speeds	1-1
4-1	Trouble shooting Chart	4-3
5-1	Replacement Parts and Accessories.....	5-1
5-2	Bakeout Heaters	5-2

Preface

Overview - Ion Pumps

Tables 1 through 4 list the Captorr Ion Pumps that Physical Electronics manufactures.

Table 1. *Low Profile Ion Pumps with Flat Pole Pieces.*

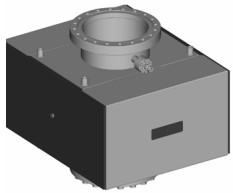

Description	Port Configuration	Part Number
Low Profile 80 l/s Differential Diode	Single NW 100 CF (6" CFF)	3086080
80 l/s Differential Diode	Double NW 100 CF (6" CFF)	3086082
100 l/s Conventional Diode	Single NW 100 CF (6" CFF)	3086100
100 l/s Conventional Diode	Double NW 100 CF (6" CFF)	3086102
Low Profile 160 l/s Differential Diode	Single NW 150 CF (8" CFF)	3088160
160 l/s Differential Diode	Double NW 150 CF (8" CFF)	3088162
200 l/s Conventional Diode	Single NW 150 CF (8" CFF)	3088200
200 l/s Conventional Diode	Double NW 150 CF (8" CFF)	3088202
Low Profile 240 l/s Differential Diode	Single NW 150 CF (8" CFF)	3088240
240 l/s Differential Diode	Double NW 150 CF (8" CFF)	3088242
300 l/s Conventional Diode	Single NW 150 CF (8" CFF)	3088300
300 l/s Conventional Diode	Double NW 150 CF (8" CFF)	3088302
Low Profile 320 l/s Differential Diode, stacked	Single NW 150 CF (8" CFF)	3098320
320 l/s Differential Diode	Double NW 150 CF (8" CFF)	3098322
320 l/s Differential Diode	Side Port NW 150 CF (8" CFF)	3098324
400 l/s Conventional Diode	Single NW 150 CF (8" CFF)	3099400
400 l/s Conventional Diode	Double NW 150 CF (8" CFF)	3099402
400 l/s Conventional Diode	Side Port NW 150 CF (8" CFF)	3099404
Low Profile 480 l/s Differential Diode, stacked	Single NW 150 CF (8" CFF)	3098480
480 l/s Differential Diode	Double NW 150 CF (8" CFF)	3098482
480 l/s Differential Diode	Side Port NW 150 CF (8" CFF)	3098484
600 l/s Conventional Diode	Single NW 150 CF (8" CFF)	3098600
600 l/s Conventional Diode	Double NW 150 CF (8" CFF)	3098602

[Cryoshroud and Sputter Shield specifications and dimensions.](#)

Table 2. *Low Profile Ion Pumps with Angle Pole Pieces.*

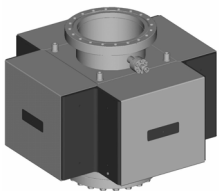

Description	Port Configuration	Part Number
Low Profile 320 l/s Differential Diode	Single NW 150 CF (8" CFF)	3088320
320 l/s Differential Diode	Double NW 150 CF (8" CFF)	3088322
400 l/s Conventional Diode	Single NW 150 CF (8" CFF)	3088400
400 l/s Conventional Diode	Double NW 150 CF (8" CFF)	3088402
Low Profile 480 l/s Differential Diode	Single NW 150 CF (8" CFF)	3088480
480 l/s Differential Diode	Double NW 150 CF (8" CFF)	3088482
600 l/s Conventional Diode	Single NW 150 CF (8" CFF)	3088600
600 l/s Conventional Diode	Double NW 150 CF (8" CFF)	3088602
Low Profile 640 l/s Differential Diode, stacked	Single NW 150 CF (8" CFF)	3088640
640 l/s Differential Diode	Double NW 150 CF (8" CFF)	3088642
800 l/s Conventional Diode	Single NW 150 CF (8" CFF)	3088800
800 l/s Conventional Diode	Double NW 150 CF (8" CFF)	3088802

Preface

Table 3.

Small Ion Pumps.

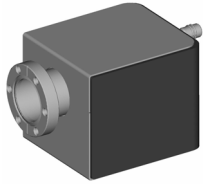

	Description	Port Configuration	Part Number
Small	10 l/s Differential Diode	Single, End NW 35 CF-R (2¾" CFR)	3282010
	12 l/s Conventional Ion Pump	Single, End NW 35 CF-R (2¾" CFR)	3282012
Small	15 l/s Differential Diode	Single, Top NW 35 CF-R (2¾" CFR)	3282015
	20 l/s Conventional Ion Pump	Single, Top NW 35 CF-R (2¾" CFR)	3282020
	15 l/s Differential Diode	Single, Top NW 63 CF-R (4½" CFR)	3284015
	20 l/s Conventional Ion Pump	Single, Top NW 63 CF-R (4½" CFR)	3284020
Small	30 l/s Differential Diode	Single, Top NW 35 CF-R (2¾" CFR)	3282030
	35 l/s Conventional Ion Pump	Single, Top NW 35 CF-R (2¾" CFR)	3282035
	30 l/s Differential Diode	Single, End NW 35 CF-R (2¾" CFR)	3292030
	35 l/s Conventional Ion Pump	Single, End NW 35 CF-R (2¾" CFR)	3292035
Small	35 l/s Differential Diode	Single, Top NW 63 CF-R (4½" CFR)	3284035
	40 l/s Conventional Ion Pump	Single, Top NW 63 CF-R (4½" CFR)	3284040
	35 l/s Differential Diode	Double NW 35, 63 CF-R (2¾", 4½" CFR)	3304035
	40 l/s Conventional Ion Pump	Double NW 35, 63 CF-R (2¾", 4½" CFR)	3304040

Table 4.

Tall Profile Ion Pumps with Cupped Pole Pieces.

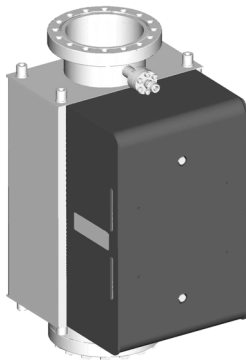

	Description	Port Configuration	Part Number
Tall Profile	120 l/s Differential Diode	Single NW 100 CF (6" CFF)	3096120
	120 l/s Differential Diode	Double NW 100 CF (6" CFF)	3096122
	120 l/s Differential Diode	Side Port NW 100 CF (6" CFF)/NW 150 CF (8" CFF)	3096124
	150 l/s Conventional Diode	Single NW 100 CF (6" CFF)	3096150
	150 l/s Conventional Diode	Double NW 100 CF (6" CFF)	3096152
	150 l/s Conventional Diode	Side Port NW 100 CF (6" CFF)/NW 150 CF (8" CFF)	3096154
Tall Profile	160 l/s Differential Diode	Single NW 100 CF (6" CFF)	3096160
	160 l/s Differential Diode	Double NW 100 CF (6" CFF)	3096162
	160 l/s Differential Diode	Side Port NW 100 CF (6" CFF)/NW 150 CF (8" CFF)	3096164
	200 l/s Conventional Diode	Single NW 100 CF (6" CFF)	3096200
	200 l/s Conventional Diode	Double NW 100 CF (6" CFF)	3096202
	200 l/s Conventional Diode	Side Port NW 100 CF (6" CFF)/NW 150 CF (8" CFF)	3096204
Tall Profile	200 l/s Differential Diode	Single NW 150 CF (8" CFF)	3098200
	200 l/s Differential Diode	Double NW 150 CF (8" CFF)	3098202
	200 l/s Differential Diode	Side Port NW 150 CF (8" CFF)	3098204
	250 l/s Conventional Diode	Single NW 150 CF (8" CFF)	3098250
	250 l/s Conventional Diode	Double NW 150 CF (8" CFF)	3098252
	250 l/s Conventional Diode	Side Port NW 150 CF (8" CFF)	3098254
Tall Profile	240 l/s Differential Diode	Single NW 150 CF (8" CFF)	3098240
	240 l/s Differential Diode	Double NW 150 CF (8" CFF)	3098242
	240 l/s Differential Diode	Side Port NW 150 CF (8" CFF)	3098244
	300 l/s Conventional Diode	Single NW 150 CF (8" CFF)	3098300
	300 l/s Conventional Diode	Double NW 150 CF (8" CFF)	3098302
	300 l/s Conventional Diode	Side Port NW 150 CF (8" CFF)	3098304
Tall Profile	400 l/s Differential Diode	Single NW 150 CF (8" CFF)	3098400
	400 l/s Differential Diode	Double NW 150 CF (8" CFF)	3098402
	400 l/s Differential Diode	Side Port NW 150 CF (8" CFF)	3098404
	500 l/s Conventional Diode	Single NW 150 CF (8" CFF)	3098500
	500 l/s Conventional Diode	Double NW 150 CF (8" CFF)	3098502
	500 l/s Conventional Diode	Side Port NW 150 CF (8" CFF)	3098504

Ion Pump Description

Ion pumps provide the following features:

- starting at 10^{-3} torr and continuous operation from 10^{-5} torr to UHV
- clean noncontaminating pumping with no backstreaming of hydrocarbons
- no loss of vacuum after power failure
- vibration-free pumping
- pump current is an indicator of pressure — possibly eliminating the need for an additional pressure gauge
- high reliability
- low maintenance
- long life
- low power consumption
- quiet
- can be mounted in any orientation

UHV Practices

When operating your ion pump, use ultra high vacuum practices. Avoid high-vapor pressure metal and hydrocarbon contamination. Ion pumps can pump light hydrocarbons.

Ion Pump Operation

When pressure in a vacuum system has been reduced to less than a few microns by means of a roughing pump, high voltage is applied between the cathode and the ring-shaped anodes of the ion pump. (For best performance, the DIGITEL 500 is recommended for providing high voltage.) Electrons are accelerated toward the anodes, but the magnetic field forces them to oscillate and spiral (helix path) in the anode space. This increased path length increases the probability of electrons colliding with gas molecules.

Positive ions formed in the collisions bombard the cathode plate, which consists of a chemically active metal (titanium). The ions combine with the active cathode material and eject more cathode atoms. These uncharged atoms, which are unaffected by electrical and magnetic fields, are mainly deposited on anode surfaces. In this way, a continuously replenished film of active cathode material is deposited on the anodes. Chemically active gas molecules (such as nitrogen, oxygen, and hydrogen), which are present in the discharge region, combine with the active metal atoms to form solid compounds and are effectively pumped from the system.

Preface

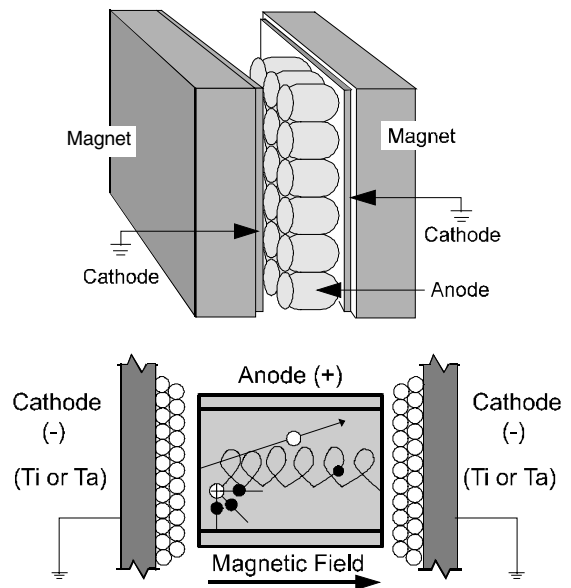
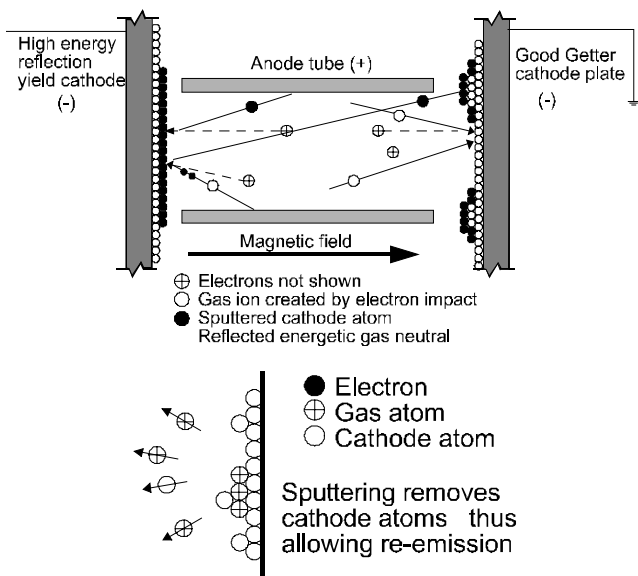

The pumping mechanism buries inert gases in the pump surfaces. When inert gases are ionized, they accelerate to the cathode. Upon impact, they either penetrate several atomic layers and become trapped within the cathode lattice structure (but are re-emitted if the entrapping lattice atoms are sputtered away), or reflect as energetic neutrals and become embedded and trapped in the pump surfaces that see little or no sputtering, such as the anode surfaces and the cathode surfaces around the periphery of the penning cells.

The magnetic field directly effects the pumping speed of the pump. The pumps use a ceramic eight (barium ferrite) magnet. This material exhibits a reversible field loss of 0.2% per degree Celsius and an irreversible field loss of 7% at 350°C. This loss is non-cumulative. (subsequent bakeouts to 350°C do not cause an additional irreversible loss). **Under no circumstances should the magnet temperature be brought above 350°C.** Above 85°C, the pumping speed of the pump declines with temperature. Ion pumps have difficulty maintaining operation above 250°C because of magnetic field loss, and increased gas load as gases desorb from internal surfaces.

Conventional Ion Pump (High Vacuum)

Conventional ion pumps provide the highest air pumping speed and the highest active gas pumping speed. Typically, the pumping speed for inert gases is an order of magnitude lower than for active gases. Because of the lower pumping speed of inert gases and other gases that do not readily combine with titanium, conventional ion pumps are best used at pressures higher than 5×10^{-8} torr and when inert gases will not be intentionally introduced.

Differential Ion Pump (Ultra High Vacuum)

Some types of ion pumps experience large periodic pressure fluctuations while pumping mixtures containing inert gases. These fluctuations, called "argon instability," occur both when pumping air at UHV (1% argon by volume) and when pumping pure argon or other inert gases. "Air-stable" is the term used to describe an ion pump that can pump against an air leak without becoming unstable. An "argon-stable" pump is one that can pump against a

Preface

100% argon leak without becoming unstable. The differential ion (DI) pump design provides both capabilities, air-stability and argon-stability, in a single pump.

Most inert gases are pumped on the anode structure and at the peripheral areas of the cathode where the sputtering rate is so low that total re-emission does not occur. Energetic reflected neutrals readily reach these peripheral areas and the anode surfaces because the neutrals are not affected by the magnetic field. Thus at a higher rate of energetic, reflected neutral formation, inert gas pumping speed would be increased. To achieve high inert gas pumping speeds, differential pumping elements with one cathode chosen for good energetic neutral production (tantalum) and one chosen for its chemical reactivity (titanium) are used.

Hydrogen Ion Pump (High Vacuum)

Short term hydrogen pumping is not a problem and is handled by most ion pumps. Long-term pumping of higher pressure hydrogen can cause saturation, as well as mechanical and electrical failure of the pump elements. The hydrogen pump is specifically designed to handle high hydrogen loads while pumping other gases. The initial pumping speed for hydrogen is 300% of air speed. It decreases with saturation, but at a rate slower than other ion pumps (approximately 220%).

The cathodes of the hydrogen ion pump element are both titanium and use heavier construction techniques to increase the operating life of the pump and prevent failure due to warpage of the cathode plates.

TSP Boostivac™ Combination Ion Pump and TSP

The boostivac pumping system combines ion pumping and titanium sublimation pumping with cryo capture to create a vacuum pump with greater pumping speeds and throughput than can be achieved by an ion pump alone. It can easily handle gas loads from a wide variety of vacuum systems.

The sublimation source for a Boostivac pump is a titanium/molybdenum alloy filament. The filament holder has four filaments that provide a total of six grams of usable titanium, insuring extended operation. It is bakeable to 400°C. When current passes through the titanium filament, the resulting heat causes active titanium to sublime and deposit on adjacent walls.

Combining sublimation and ion pumping is an effective means of pumping common residual gas, resulting in enhanced pumping of active gases such as oxygen, carbon dioxide, carbon monoxide, hydrogen, and nitrogen. Water vapor dissociates into oxygen and hydrogen and combines with the titanium as separate elements.

Cooling a cryoshroud with liquid nitrogen quickly captures water vapor and improves the sublimated titanium pumping speed for nitrogen and hydrogen. Cryo capture aids in pumping highly condensable gas loads and in achieving maximum pumpdown speed and throughput. Cryoshrouds trap high vapor pressure materials on the liquid nitrogen surface without contaminating the ion pump. The cryoshroud consists of a double-walled stainless steel cylinder with two liquid feed-throughs.

NEG Boostivac™ Combination Ion Pump and NEG Pump

NEG (nonevaporable getter) modules offer high pumping speeds and help achieve an ultrahigh vacuum (UHV) environment quickly. They are most useful in applications requiring large specific pumping speeds, infrequent up-to air cycles, and a non-magnetic gettering process. NEG modules are often used in conjunction with differential ion (DI) pumps. When combined, the two pumps provide high pumping speeds on a wider variety of gases, especially with high hydrogen gas loads or when H₂ is the primary remaining gas.

Nonevaporable Getter (NEG) pumps remove or pump active gases by *gettering* or chemically combining the gases with metal alloys. NEG modules are made of pleated copper-nickel alloy Constantan strips coated with St 707, a reactive zirconium-vanadium-iron powder mixture. St 707 reduces the chamber pressure by gettering or chemisorbing active gases like O₂, CO, and N₂ permanently on the surface of the getter base material. H₂ and its isotopes diffuse into the getter material forming a solid solution, which can later be released at higher temperatures. NEG pumps *do not* pump noble gases, but they can be used to purify the inert/noble gases.

As the St 707 in the module becomes saturated with active gases, its pumping speed decreases. At the saturation point, heating it can reactivate the strip. This diffuses active gases like O₂, CO, and N₂ deeper into the wafer structure and releases the hydrogen, which can then be pumped out of the system by an ion or supporting pump.

Section 1: Specifications

Introduction



A Low Profile Pump has several unique features. The design itself is achieved by orienting the elements vertically inside the body of the ion pump. This orientation decreases the height of the ion pump to just under 12" (300 mm) for a single port pump. The orientation also creates a closed magnetic circuit that reduces stray magnetic field by a factor of 10 near the ports of the ion pump. These pumps can be configured with additional ports either on the opposite end or on the side of the pump body. This enables easy addition of a Boostovac system or alternative orientation on a UHV system.

Pumping Speeds (Percent of Rated Speed).		
	Conventional	Differential
Hydrogen	220%	160%
Carbon Dioxide	100%	100%
Nitrogen	85%	85%
Oxygen	70%	70%
Water Vapor	100%	100%
Helium	2%	15%
Argon	5%	20%
Light Hydrocarbons	90%	90%

Captorr Variable Pocket Ion Pump Specifications					
Parameter	Specification				
Starting Pressure	All ion pumps require rough pumping of the vacuum system prior to operation. The range to start pumps is 5×10^{-4} torr or lower. Combining a Captorr Ion Pump with a DIGITEL Ion Pump Controller enables maximum control over starting the ion pump through the AutoStart and AutoRun™ features.				
Operating Pressure Range	Pressure is directly read from an ion pump through current to pressure conversion. Conversion is calculated based on nominal speed of the ion pump that it is operating. An ion pump provides accurate current information directly related to pressure between 1×10^{-4} and 1×10^{-10} torr. Ion pumps have been known to operate outside this range using alternative measuring components.				
Pumping Speed	Pumping speed for a Captorr Ion Pump is defined by the number of pumping elements the pump contains and conductance limitations of the ports. Each ion pump design has been tested or calculated to conform to a nominal value.				
Radiation Resistance	All materials are rated to meet or exceed excessive radiation exposure. Exposure beyond 5×10^9 RAD approaches the limits of external SAFE-CONN feedthrough materials (PEEK).				
Lifetime*	<table border="0"> <tr> <td>Conventional</td> <td>> 40,000 hours @ 1×10^{-6} torr</td> </tr> <tr> <td>Differential</td> <td>> 45,000 hours @ 1×10^{-6} torr</td> </tr> </table>	Conventional	> 40,000 hours @ 1×10^{-6} torr	Differential	> 45,000 hours @ 1×10^{-6} torr
Conventional	> 40,000 hours @ 1×10^{-6} torr				
Differential	> 45,000 hours @ 1×10^{-6} torr				
Mounting	Pumps with flanges 4.5" in diameter and smaller may be operated in any orientation without external support. Pumps with flanges larger than 4.5" are strong enough to be mounted on a chamber in a vertical position, but are too heavy to cantilever from the chamber without additional support. All ion pumps require external support during shipment or in case of vibration.				
Bakeout Capabilities	For periodic degassing of pump surfaces, optional bakeout heaters enable the pump to be heated to 150°C (sufficient for desorption of water vapor) in eight hours. These heaters are designed to obtain the most efficient, uniform heating possible.				

* Lifetime increases proportionally to operating pressure

1: Specifications

Low Profile 100

Specifications				
Part Number 6" flange	3086100	3086102	3086080	3086082
Port Configuration	Single 6" CFF	Double 6" CFF	Single 6" CFF	Double 6" CFF
Weight	28.5 kg (62.8 lb)	31 kg (68.3 lb)	28.5 kg (62.8 lb)	31 kg (68.3 lb)
Part Number 8" flange	3088100	3088102	3088080	3088082
Port Configuration	Single 8" CFF	Double 8" CFF	Single 8" CFF	Double 8" CFF
Weight	28.6 kg (63 lb)	31.1 kg (68.5 lb)	28.6 kg (63 lb)	31.1 kg (68.5 lb)
Nominal Pumping Speed	100 1/s (Conventional Diode)		80 1/s (Differential Diode)	
Operating life	40,000 hours at 1×10^{-6} torr			
Operating voltage	Positive; 3500 to 7000V			
Maximum starting pressure	1×10^{-3} torr (lower pressure is better)			
Operating bake temperature	250° C maximum			
Maximum bake temperature:	350° C with ferrite magnets (pump off); 250° C with samarium-cobalt magnets (pump off); 450° C without magnets (pump off)			
Heater Kits	2190211 (110 Vac/800 Watts); 2190212 (220 Vac/800 Watts)			
Boostovac Compatible	—			
Recommended power supply	DIGITEL™ Multiple Pump Control			
High-voltage, bakeable, SAFE-CONN™ cables	3m (642453); 6m (642454); 10m (642455); 15m (642456); 20m (642457); 30m (642458); 40m (643506); 50m (643507); 75m (643508); 100m (643509);			

Dimensions mm (in.)

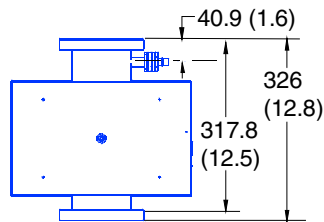
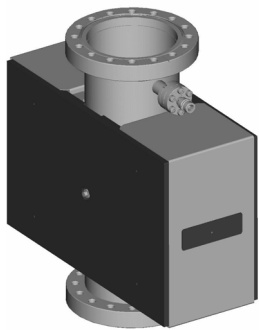

NW 100 CF (6.0" CFF)

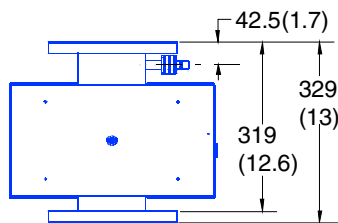
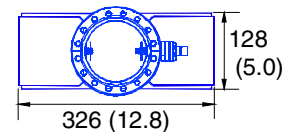
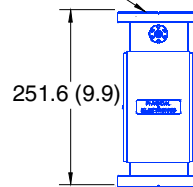

NW 150 CF (8.0" CFF)

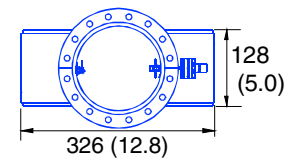
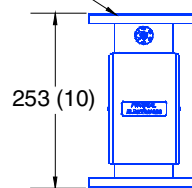

Speed vs Pressure Curve — 100/80 l/s

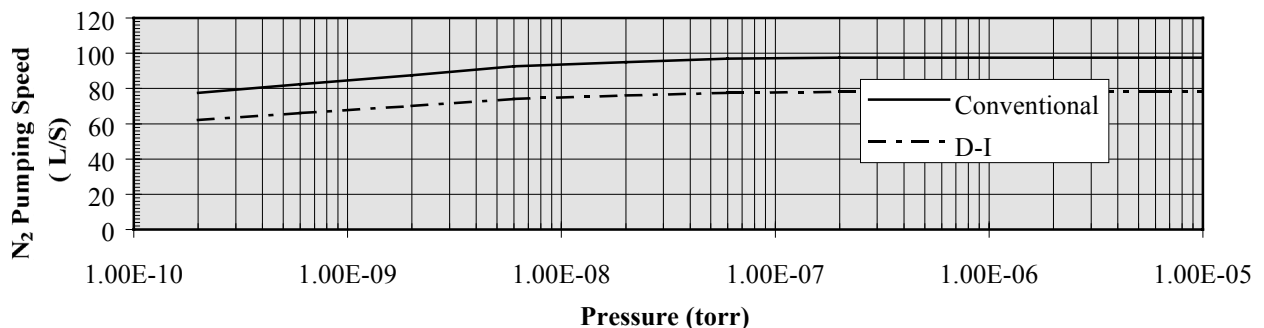

1: Specifications

Current vs Pressure Curve — 100/80 I/s

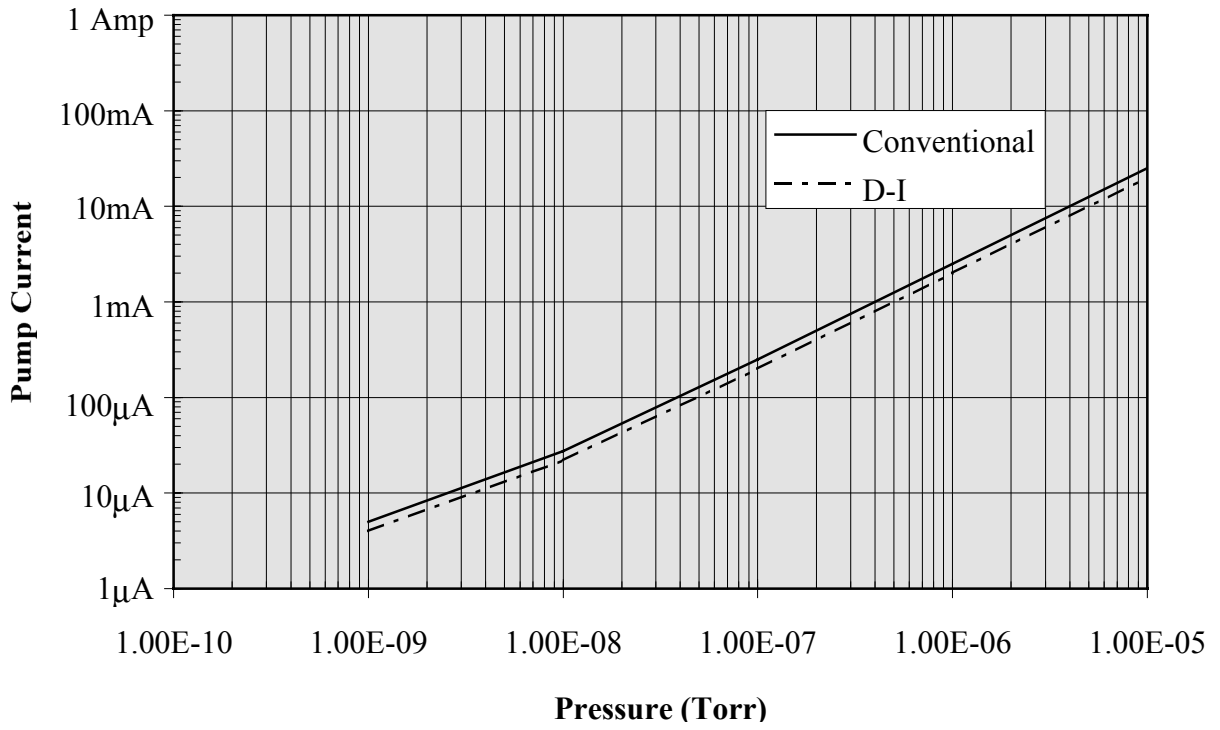

Magnetic Field Plots — 100/80 I/s

Front View
Grid: 25.4mm (1 in)

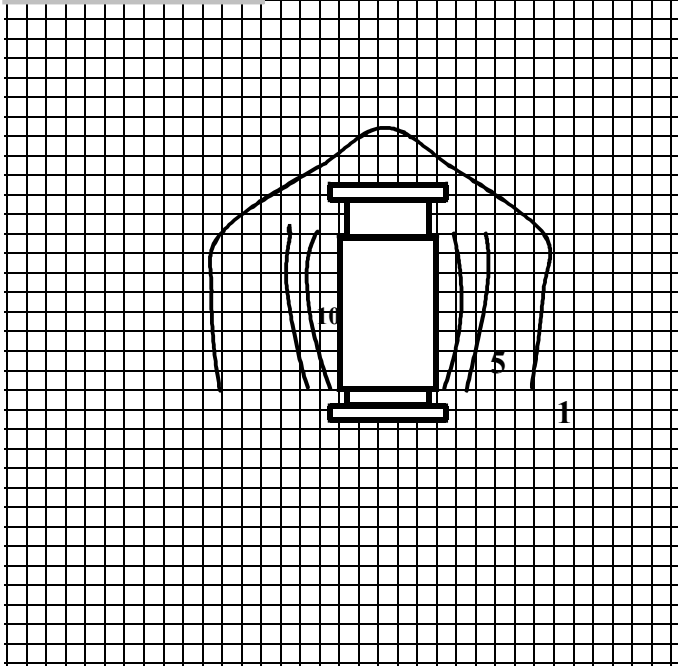

Side View
Grid: 25.4mm (1 in)

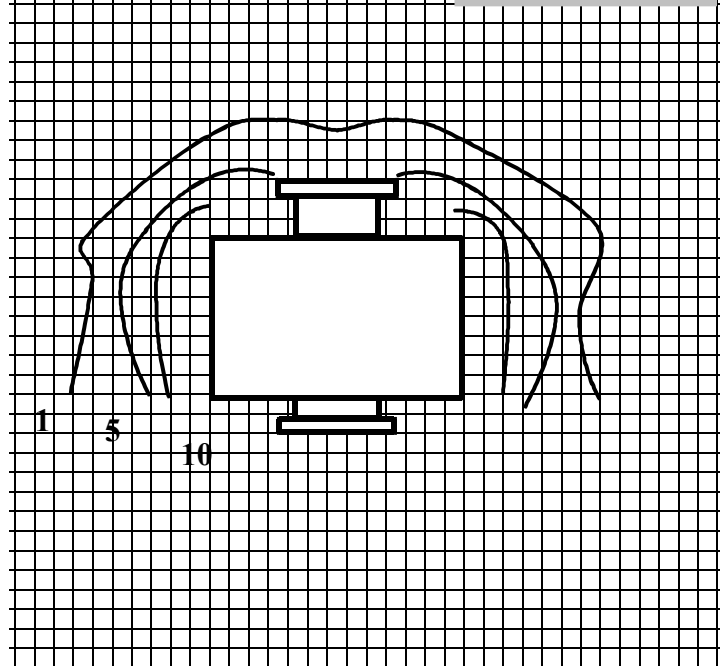

1: Specifications

Low Profile 200

Specifications			
Part Number	3088200	3088202	3088160 3088162
Port Configuration	Single 8" CFF	Double 8" CFF	Single 8" CFF Double 8" CFF
Nominal Pumping Speed	200 1/s (Conventional Diode)		160 1/s (Differential Diode)
Weight	46 kg (101.4 lb) single flange; 49 kg (108 lb) double flange		
Operating life	40,000 hours at 1×10^{-6} torr		
Operating voltage	Positive; 3500 to 7000V		
Maximum starting pressure	1×10^{-3} torr (lower pressure is better)		
Operating bake temperature	250°C maximum		
Maximum bake temperature:	350°C with ferrite magnets (pump off); 250°C with samarium-cobalt magnets (pump off) 450°C without magnets (pump off)		
Heater Kits	2190431 (110 Vac/1200 Watts); 2190432 (220 Vac/1200 Watts)		
Boostovac Compatible	—	TSP/NEG	— TSP/NEG
Recommended power supply	DIGITEL Multiple Pump Control		
High-voltage, bakeable, SAFE-CONN™ cables	3m (642453); 6m (642454); 10m (642455); 15m (642456); 20m (642457); 30m (642458) ; 40m (643506); 50m (643507); 75m (643508); 100m (643509);`		

Dimensions mm (in.)

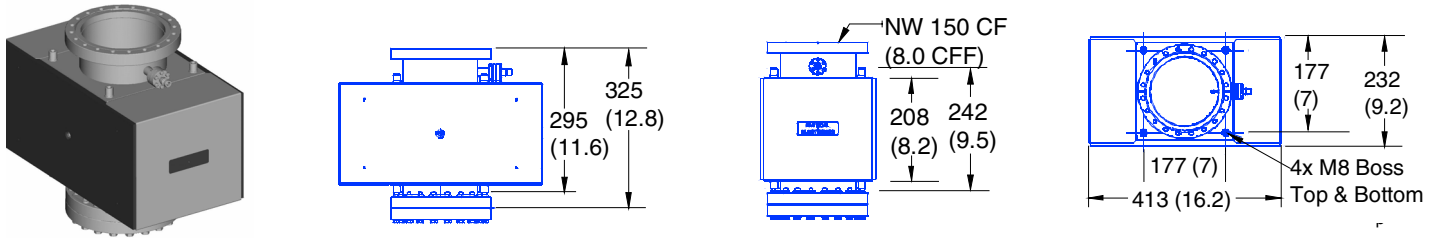

Speed vs Pressure Curve — 200/160 I/s

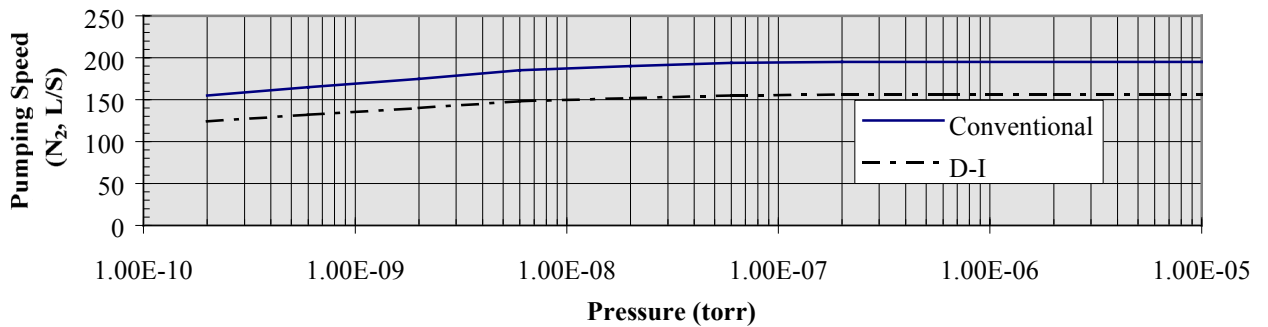

1: Specifications

Current vs Pressure Curve — 200/160 I/s

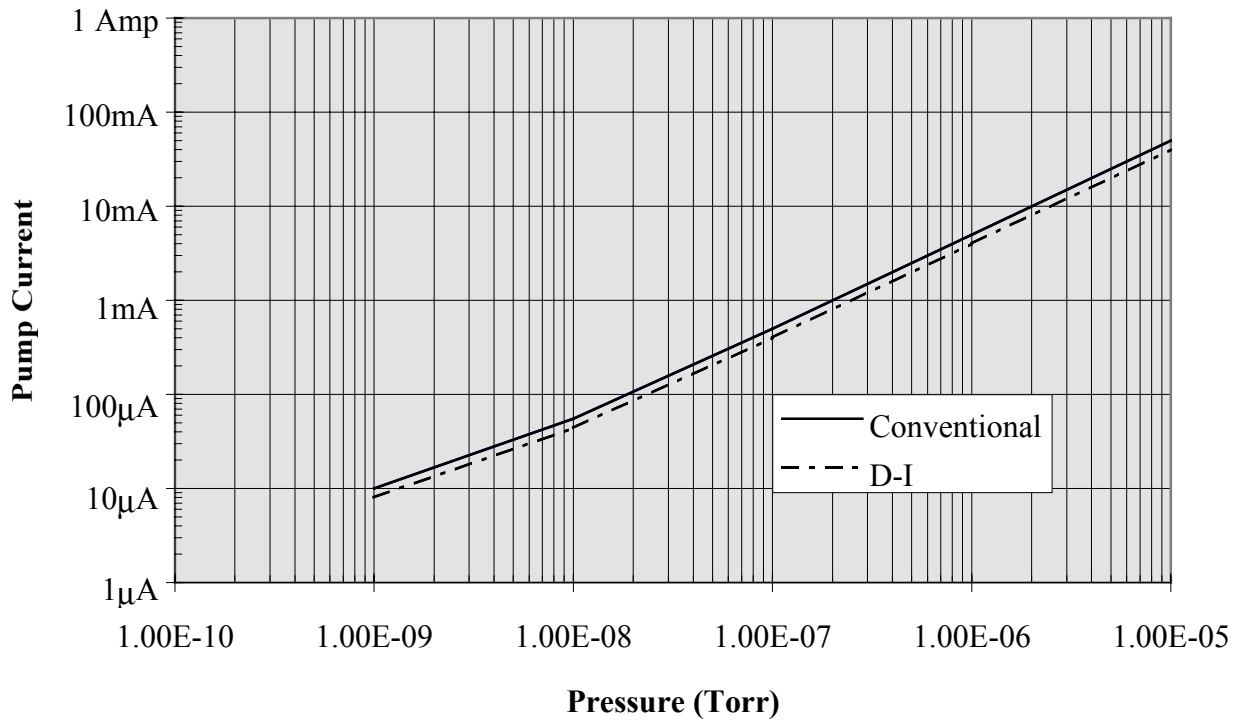

Magnetic Field Plots — 200/160 I/s

Not available at this time.

1: Specifications

Low Profile 300

Specifications				
Part Number	3088300	3088302	3088240	3088242
Port Configuration	Single 8" CFF	Double 8" CFF	Single 8" CFF	Double 8" CFF
Nominal Pumping Speed	300 1/s (Conventional Diode)		240 1/s (Differential Diode)	
Weight	58.1 kg (128.1 lb) single flange; 66 kg (145.4 lb) double flange			
Operating life	40,000 hours at 1×10^{-6} torr			
Operating voltage	Positive; 3500 to 7000V			
Maximum starting pressure	1×10^{-3} torr (lower pressure is better)			
Operating bake temperature	250° C maximum			
Maximum bake temperature:	350° C with ferrite magnets (pump off); 250° C with samarium-cobalt magnets (pump off) 450° C without magnets (pump off)			
Heater Kits	2190731 (110 Vac/1200 Watts);		2190732 (220 Vac/1200 Watts)	
Boostvac Compatible	— TSP/NEG		— TSP/NEG	
Recommended power supply	DIGITEL Multiple Pump Control			
High-voltage, bakeable, SAFE-CONN™ cables	3m (642453); 6m (642454); 10m (642455); 15m (642456); 20m (642457); 30m (642458); 40m (643506); 50m (643507); 75m (643508); 100m (643509);`			

Dimensions mm (in.)

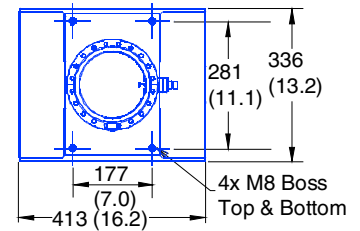
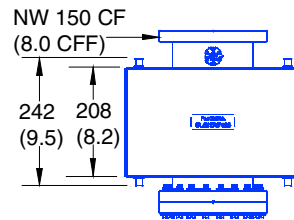
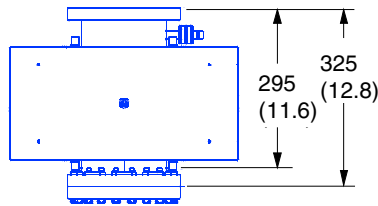
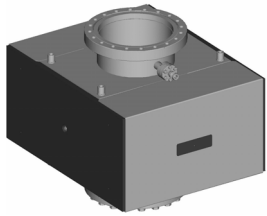

Speed vs Pressure Curve — 300/240 I/s

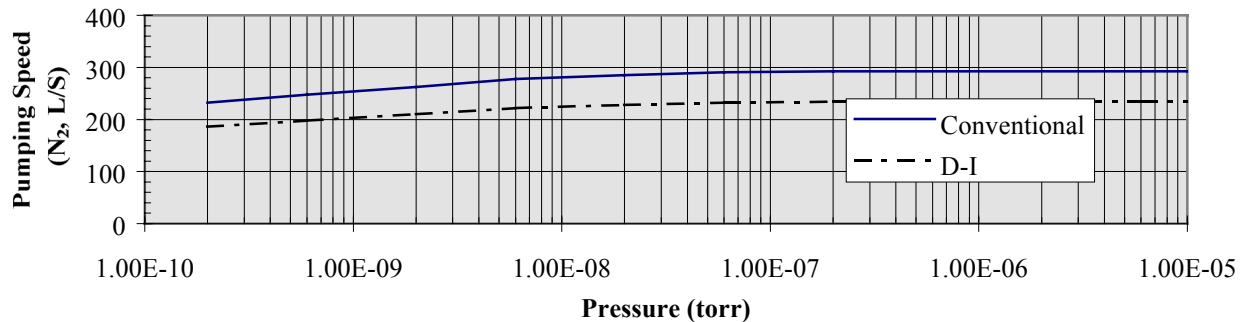

1: Specifications

Current vs Pressure Curve — 300/240 I/s

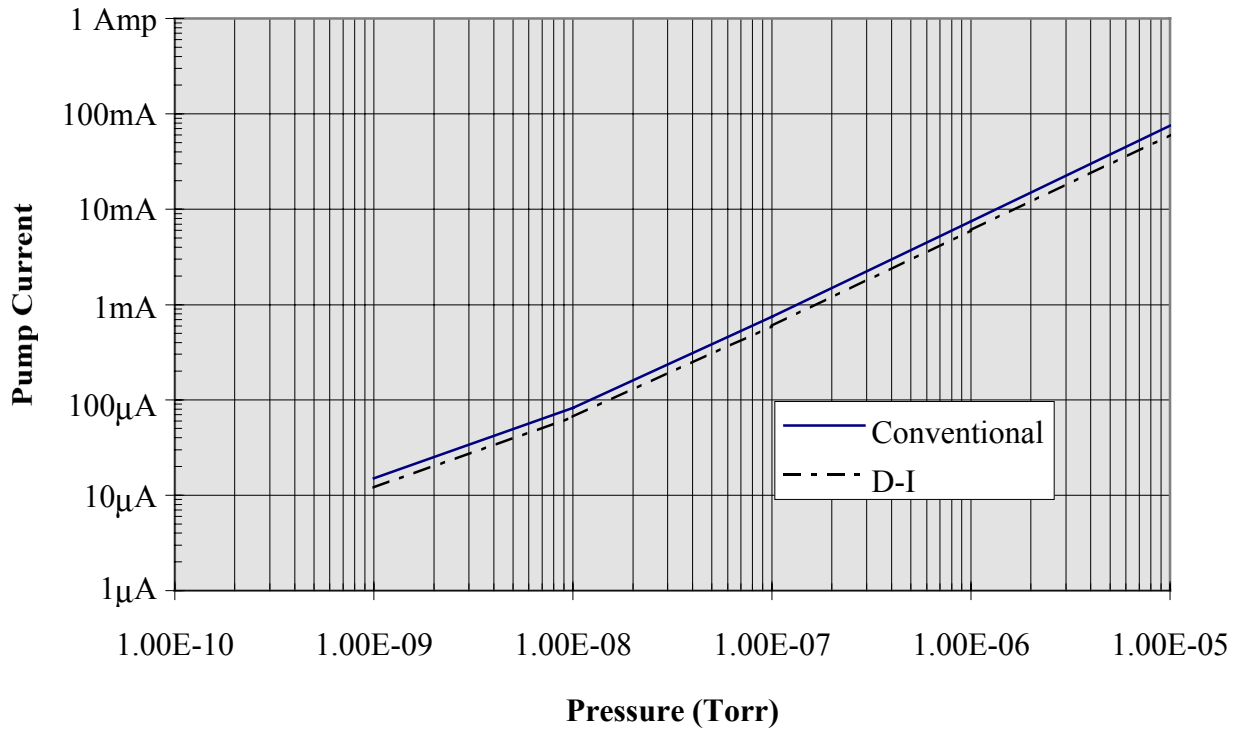

Magnetic Field Plots — 300/240 I/s

Not available at this time

1: Specifications

Low Profile 400 Stacked

Specifications						
Part Number	3099400	3099402	3099404	3098320	3098322	3098324
Port Configuration	Single 8" CFF	Double 8" CFF	SP* 8" CFF	Single 8" CFF	Double 8" CFF	SP* 8" CFF
Nominal Pumping Speed	400 l/s (Conventional Diode)			320 l/s (Differential Diode)		
Weight	85 kg (187.4 lb) single flange; 88 kg (194 lb) double or side port flange					
Operating life	40,000 hours at 1 x 10 ⁻⁶ torr					
Operating voltage	Positive; 3500 to 7000V					
Maximum starting pressure	1 x 10 ⁻³ torr (lower pressure is better)					
Operating bake temperature	250° C maximum					
Maximum bake temperature:	350° C with ferrite magnets (pump off); 250° C with samarium-cobalt magnets (pump off) 450° C without magnets (pump off)					
Heater Kits	2191031 (110 Vac/2400 Watts);			2191032 (220 Vac/2400 Watts)		
Boostvac Compatible	—	TSP/NEG	TSP	—	TSP/NEG	TSP
Recommended power supply	DIGITEL Multiple Pump Control					
High-voltage, bakeable, SAFE-CONN™ cables	3m (642453); 6m (642454); 10m (642455); 15m (642456); 20m (642457); 30m (642458); 40m (643506); 50m (643507); 75m (643508); 100m (643509);`					

* SP = Side Port

Dimensions mm (in.)

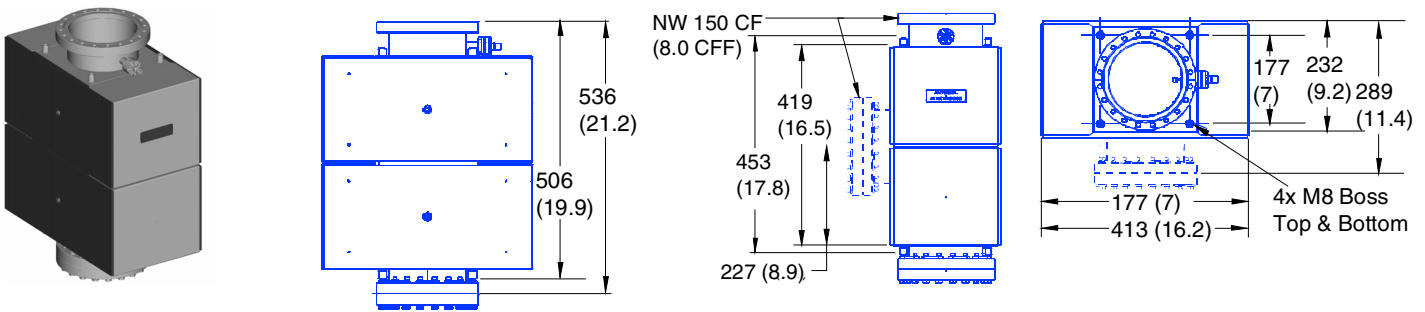

Speed vs Pressure Curve — 400/320 l/s

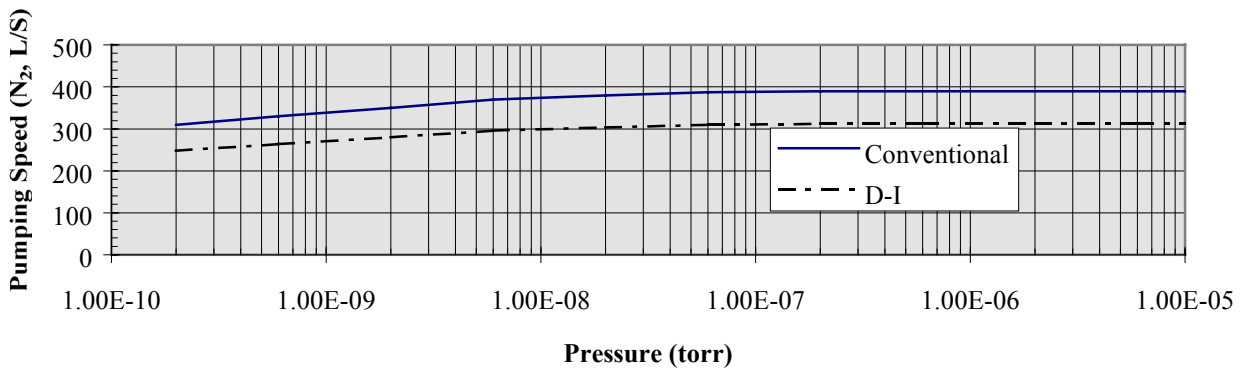

1: Specifications

Current vs Pressure Curve — 400/320 I/s

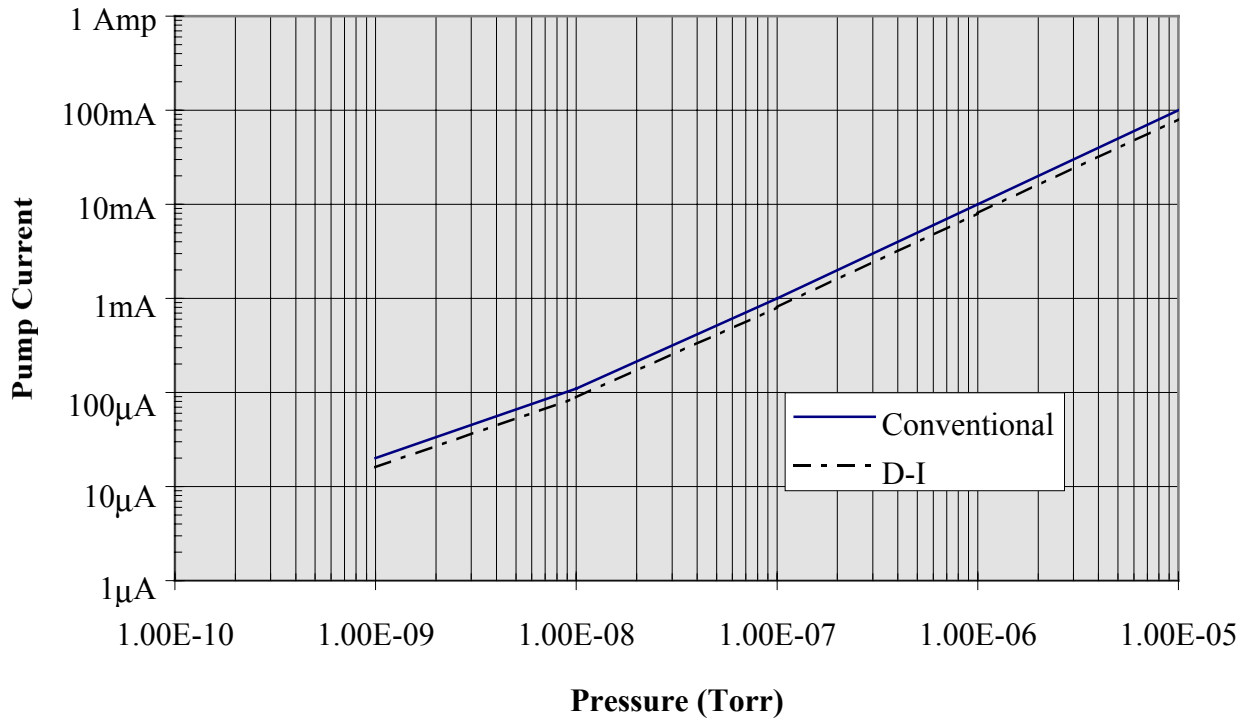

Magnetic Field Plots — 400/320 I/s

Not available at this time

1: Specifications

Low Profile 600 Stacked

Specifications						
Part Number	3098600	3098602	3098604	3098480	3098482	3098484
Port Configuration	Single 8" CFF	Double 8" CFF	SP* 8" CFF	Single 8" CFF	Double 8" CFF	SP* 8" CFF
Nominal Pumping Speed	600 l/s (Conventional Diode)			480 l/s (Differential Diode)		
Weight	110 kg (242.5 lb) single flange; 115 kg (253.5 lb) double or side port flange					
Operating life	40,000 hours at 1×10^{-6} torr					
Operating voltage	Positive; 3500 to 7000V					
Maximum starting pressure	1×10^{-3} torr (lower pressure is better)					
Operating bake temperature	250° C maximum					
Maximum bake temperature:	350° C with ferrite magnets (pump off); 250° C with samarium-cobalt magnets (pump off); 450° C without magnets (pump off)					
Heater Kits	2191331 (110 Vac/2400 Watts);			2191332 (220 Vac/2400 Watts)		
Boostovac Compatible	—	TSP/NEG	TSP	—	TSP/NEG	TSP
Recommended power supply	DIGITEL Multiple Pump Control					
High-voltage, bakeable, SAFE-CONN™ cables	3m (642453); 6m (642454); 10m (642455); 15m (642456); 20m (642457); 30m (642458); 40m (643506); 50m (643507); 75m (643508); 100m (643509);`					

* SP = Side Port

Dimensions mm (in.)

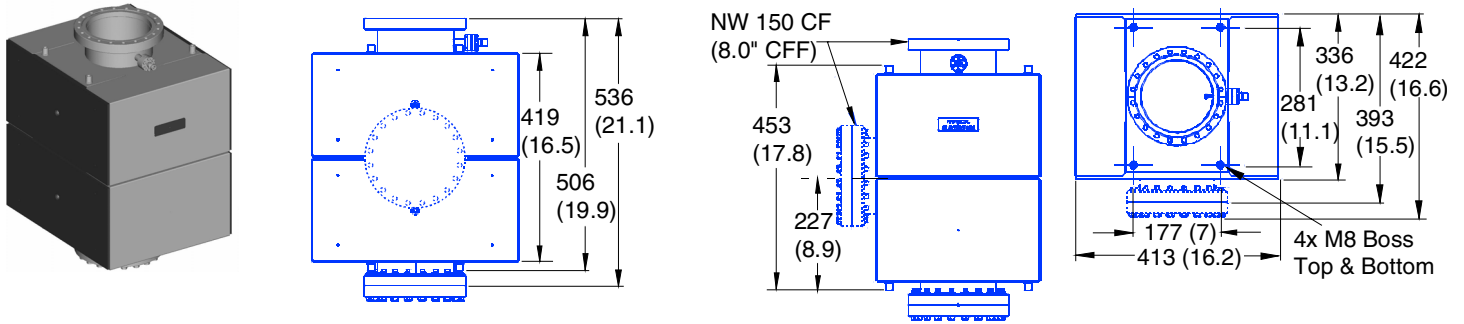

Speed vs Pressure Curve — 600/480 l/s

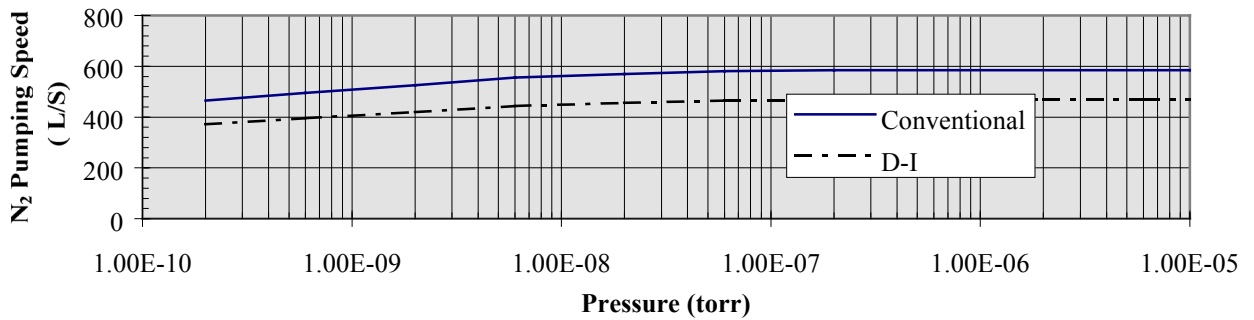

1: Specifications

Current vs Pressure Curve — 600/480 I/s

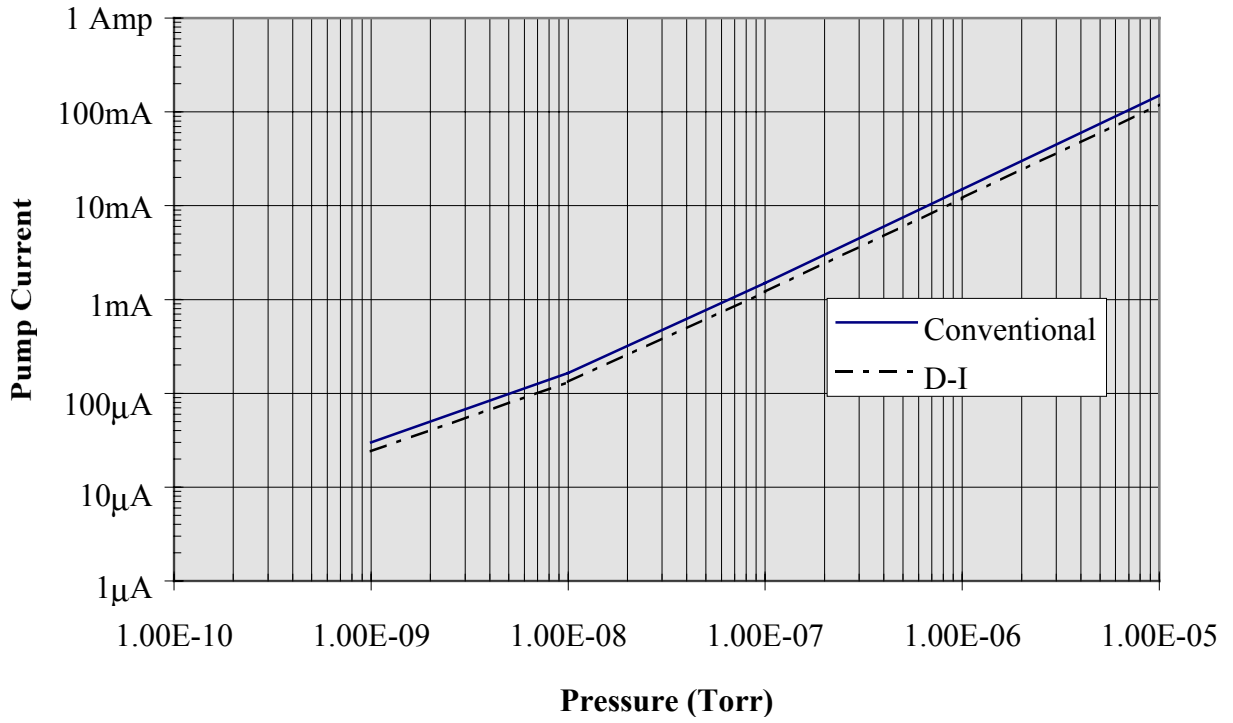

Magnetic Field Plots — 600/480 I/s

Not available at this time

1: Specifications

Boostivac Pumping

This subsection provides the specifications and dimensions for the Cryoshrouds and Sputter Shields used in Boostivac Pumping.

Liquid Nitrogen (LN₂) Cryoshrouds

Cryoshrouds can be used with nothing, with water, or with LN₂. When used with LN₂, hydrogen-pumping speeds are tripled. A cryoshroud provides capture and hold of H₂O & CO₂ pumping when cooled with LN₂. It provides a surface for sublimated titanium while preventing line of sight migration of Ti.

Material	Double-walled, type 321 stainless steel cylinder.
Feedthrough: mm (in.)	Two LN ₂ feedthroughs: 9.5 (0.375) diameter with 37° flare-type fittings.
Surface Area	Over 200 square in. of liquid nitrogen-cooled surface area.
Mounting: mm (in.)	203 (8") O.D. CF flange, center 3.75" CFF.
Volume	1.15 liters of liquid nitrogen.

Dimensions: mm (inches)

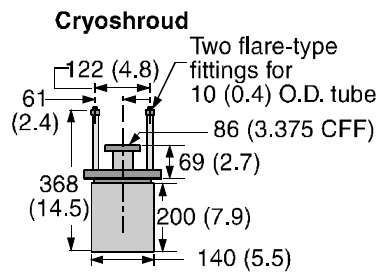
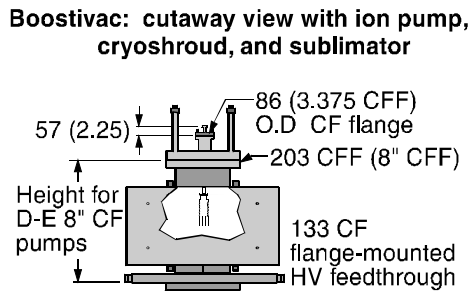

Ambient Sputter Shields

An ambient sublimation shield provides a surface for sublimated titanium while preventing line of sight migration of Ti. It is low in cost and has reduced dimensions.

Dimensions: mm (inches)

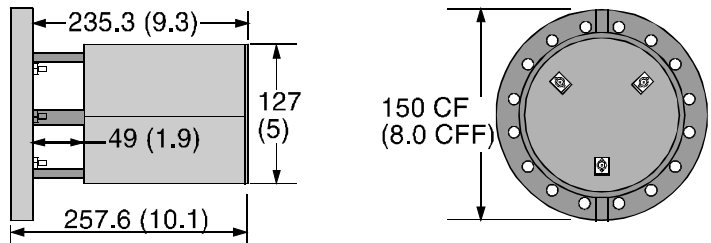

Section 2: Installation

This section details the installation requirements for Captorr Ion Pumps.



WARNING: *Physical Electronics' (PHI's) products are designed and manufactured to provide protection against electrical and mechanical hazards for the operator and the area surrounding the product. The procedures provided in Sections 2 and 5 of this manual and in other PHI product manuals must be followed to ensure that these protections are not impaired in any way.*

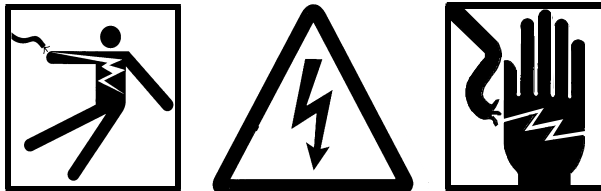

WARNING: *Installation procedures are for use by qualified and authorized personnel who have experience working with voltages greater than 50 volts. To avoid personal injury, do not perform any installation or service procedures unless qualified to do so.*

The ion pump controller can deliver in excess of 7000V under open circuit or low pressure operation. Make sure that the ion pump controller and ion pump have a common chassis connection tied to power system ground.



WARNING: *Heavy lifting could cause personal injury. In order to move the heavier ion pumps, eyebolts or lifting attachments are available on the pumps. Threaded bosses for eyebolt attachment may be metric thread.*

Unpacking and Inspecting for Damage

Unpack the ion pump carefully. Do not remove or damage the plastic tube on the copper pinch-off seal before evacuating the pump. The ion pump should be kept under vacuum until it is installed on the system.

NOTE: It is the customer's responsibility to inspect and report any shipping damage to the carrier, typically within 30 days. Before installing PHI equipment, inspect it for damage that may have occurred during shipment.

Initial Checkout

PHI ships ion pumps under vacuum to insure ultra high vacuum cleanliness and to demonstrate the vacuum integrity of the ion pump vessel. After initial unpacking and before venting the ion pump, connect the ion pump to the ion pump controller and switch on high voltage. The ion pump should start immediately with no arcing and after 15 minutes of operation, ion pump current should be less than 1 μA .

Ion Pump Installation

Tools required to install the ion pump are to be used on equipment by technicians only, not by operators.* Figure 2-1 shows installation connections for a typical vacuum system. To reach ultimate system pressures, optional bakeout heaters may be installed.

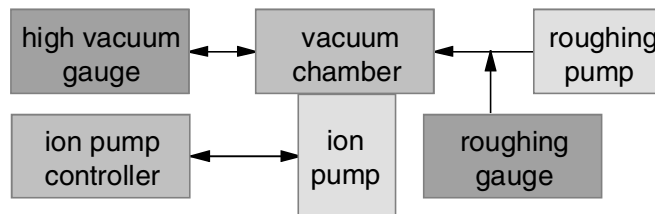
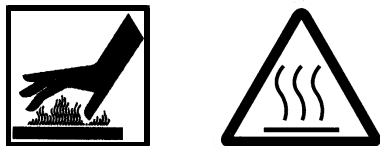

Figure 2-1. Installation Connections for a Typical Vacuum System.



WARNING: *If heaters are installed, they are extremely hot to the touch. To avoid severe injury, isolate the pump so that no one can touch the heaters.*

1. Use a pliers or non-cutting tool to open the pinch-off seal. Preferably, vent the ion pump to dry nitrogen.

* “PHI Safety Notices” at the beginning of this document describes who is an operator and who is a technician.

2: Installation

1. Use a pliers or non-cutting tool to open the pinch-off seal. Preferably, vent the ion pump to dry nitrogen.
2. Remove the blank-off flange from the ion pump.
NOTE: Ion pumps with flanges 4.5" diameter and smaller may be mounted in any orientation without external support. Those with larger flanges can be mounted on a chamber in a vertical position, but are too heavy to cantilever from the chamber without additional support. All ion pumps require external support in case of vibration and during shipping. Mounting bosses are provided for easy integration.
3. Bolt the ion pump to the system with the new gasket (supplied with the pump) and bolt set from the blank-off flange. Tighten the bolts sequentially until flanges touch.

Heater Installation

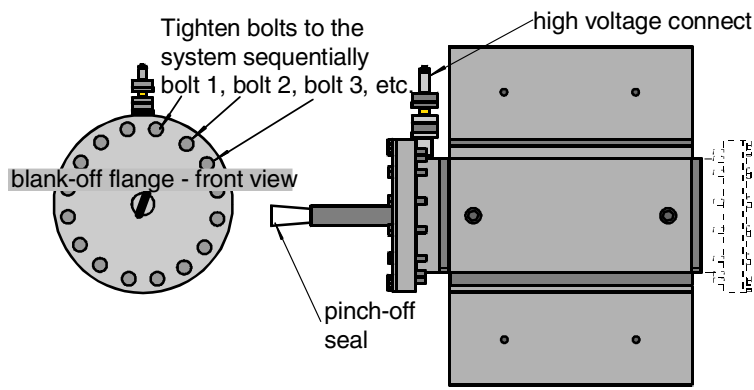

Figure 2-2. Installing the Ion Pump.

4. Although the high voltage cable has a grounded shield, take a separate wire (with a ring terminal on each end) and connect it from the body of the ion pump to the ion pump controller. An additional ground cable is typically provided with the ion pump controller.



WARNING: *The ion pump controller can deliver an excess of 7000V under open circuit or low-pressure operation. Make sure that the ion pump controller and ion pump have a common chassis connection that is tied to power system ground.*

5. First connect the high voltage cable to the ion pump. Then connect it to the ion pump controller.
6. With the ion pump controller switched off, attach the power cord and plug it into a properly grounded outlet.

Heater Installation

Typically, heaters are installed at the factory. Use the following procedure to install heaters on ion pumps.



WARNING: *Heaters are extremely hot to the touch. To avoid severe injury, isolate the pump so that no one is able to touch the heaters.*

1. Make sure that you install the flat smooth side of the heater against the outside of the pole piece (figure below).
2. Install it firm (it must be able to expand when heated).

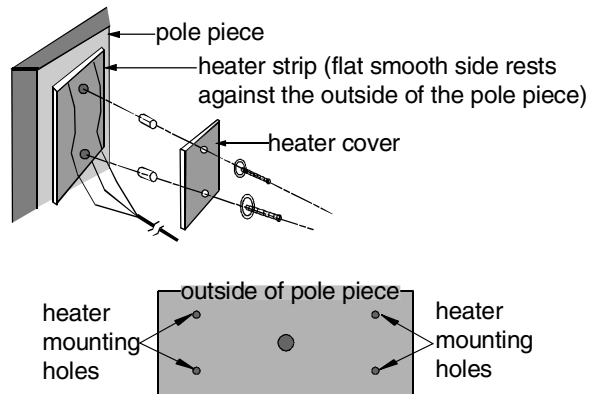

Figure 2-3. Heater Installation Diagram.

Section 3:

Operation

This section contains information on pump roughing, pump starting, opening the system to atmospheric pressure, and pump bakeout.

Before operating the ion pump:

- Before operating your ion pump, please read the following recommendations:
- Ensure that the air and environment are free from contaminants.
- Hands should be gloved and free from oils. Use UHV practices when working with ion pumps.
- For better starting and pumpdown time, flush the system with dry nitrogen to decrease water vapor and noble gas quantities.
- Check to see that the ion pump controller is properly connected and that the system is tightly sealed.
- To increase ion pump life and shorten time to ultimate pressure, use the full extent of the roughing system and start the ion pump at the lowest possible pressure.

Pump Roughing

Rough pumping is performed in order to achieve a pressure at which the ion pump will start and to remove a high volume of gas load.



CAUTION: Care must be taken to avoid contaminating the ion pump with hydrocarbons from oils used to seal mechanical pumps.

Rough pump the system after you install the ion pump on the system. Refer to the roughing pump manufacturer's manual for instructions on roughing procedures, proper operation, and venting.

Rough pumping must reduce system pressure to 1×10^{-3} torr or lower. Lower roughing pressure enables the ion pump to start quicker, reduces the time required to achieve ultimate pressure, and increases ion pump life.

Pump Starting



CAUTION: *Do not leave the ion pump unattended with the ion pump controller in the start position, if so equipped. Overheating and damage to the ion pump may occur.*

Start Procedure with No Isolation Valve

This procedure is used when the ion pump is started after exposure to atmospheric pressure or any pressure above 2.5×10^{-2} torr.

1. Switch on the roughing pump and open the roughing valve.
2. On the ion pump controller, set the meter readout display to voltage. Set the ion pump controller switch to start, if so equipped.
3. Switch on the ion pump controller when system pressure has reached 1×10^{-3} torr (lower pressure is better).
4. The meter should read 300 to 500 volts and slowly increase to full voltage (normally 5000 to 7000 volts).
5. Close the roughing valve when the meter reads 2000V or greater.
6. When the meter reads 3,500 volts, set the power unit switch to run, if so equipped. To determine ion pump pressure, set the meter readout display to a current range, and calculate pressure by means of calibration curves found in Section 1.

NOTE: Some ion pump controllers have a selection for pressure readout.

3: Operation

Start Procedure with Isolation Valve

This procedure is used if the ion pump is under vacuum and isolated with a high-vacuum isolation valve. In this case, the ion pump is kept in operation while the remainder of the system is opened to atmosphere.

1. Check to see that the ion pump is operating properly.
2. Switch on the roughing pump and open the roughing valve.
3. On the ion pump controller, set the meter readout display to voltage. Set the ion pump controller switch to start, if so equipped.
4. When system pressure has reached 1×10^{-3} torr (lower pressure is better), begin closing the roughing valve and opening the isolation valve. Do not let ion pump voltage drop below 3 kV.
5. When voltage is greater than 3.5 kV, with the isolation valve fully open and the roughing valve fully closed, place the ion pump controller switch to run, if so equipped.

Ion Pump Operation

Once the ion pump has started, it continues to reduce pressure in the system without further attention.

The ion pump may be kept in permanent operation. The ion pump controller should provide overload protection to turn off the ion pump if system pressure rises above ion pump operating pressure.

- Other desirable features of an ion pump controller are:
- ion pump over-current protection
- safety interlocks
- voltage, current, and pressure display
- analog outputs that correspond to ion pump voltage and current
- remote control on/off
- setpoints - relays that can interlock equipment and processes, or control bakeout by ion pump current or calculated pressure
- computer interface for complete remote operation by a computer

Boostivac Pump Operation

Titanium sublimation pumping (TSP) and ion pumping are combined to form the Boostivac pumping system. In TSP, Titanium is supplied on filaments mounted on a filament holder. When heated, titanium is sublimed from the filament onto a substrate surface area in the system. The titanium combines with getterable gases and permanently removes them from the system. Ion pumps do not have the capacity to pump getterable gases as fast as titanium film. In combination, Boostivac pumping pumps all gases present.

The Boostivac pumping technique is generally used during:

- The pumpdown cycle when high pumping speeds are required for a rapid and timesaving operation.
- The operation of the system when heavy gas loads are experienced and when high throughput is demanded.

The substrate area onto which the getter titanium film is deposited can be cooled to prevent the substrate area from warming up if frequent sublimations are required. If the substrate is allowed to warm up, some of the sublimated titanium may migrate to other areas of the vacuum system. Select one of the following commonly used working temperatures depending on the size, shape, and operating requirements of your system):

- Air cooling (20 to 25° C)
- Water cooling (12 to 18° C)
- LN₂ cooling (77 to 100° K)

Up-to-Air Procedure

To enhance system performance, use dry nitrogen gas when venting the ion pump to atmospheric pressure.

NOTE: If an isolation valve is included, close it (with ion pump in operation) before opening the system. When venting the system to atmosphere, ion pump current may rise. This is not a problem if pressure remains below 1×10^{-6} .

1. Switch off the ion pump controller.
2. Connect a source of clean dry nitrogen to the up-to-air valve.



CAUTION: *When venting, do not pressurize the ion pump or vacuum system above atmospheric pressure.*

3. Open the up-to-air valve slowly to prevent dry nitrogen from entering the system too quickly.
4. Open the roughing isolation valve, gradually.

Bakeout

Bakeout reduces high gas loads. PHI bakeout heaters heat ion pumps above 150°C in free air (without covers or blankets). They heat the ion pump to a high enough temperature to adequately degas pump surfaces while preventing loss of magnetic flux. In free air, element heater temperature is self-limiting; ion pump and magnet temperatures are held to acceptable limits without a thermostat. If ion pumps are covered or insulated during bakeout, then ultimate temperature of the ion pump should be thermostatically controlled.

NOTE: Typically, heaters are installed at the factory. If you need to install heaters, see the installation procedure in Section 2.

Before you begin

During bakeout, monitor system pressure so that it does not exceed 1×10^{-5} . Initially, it may be necessary to switch the heaters off periodically and allow pressure to drop, then switch the heaters back on as the gas load is reduced. Heaters can be controlled automatically with PHI bakeout controls.



WARNING: *Heaters are extremely hot to the touch. To avoid severe injury, isolate the pump so that no one is able to touch it.*

CAUTION: *Temperatures above 350 °C can cause irreversible loss of magnetic field strength. When operating the system at 350 °C or above, remove the ferrite magnets from the ion pump (samarium-cobalt magnets should be removed above 250 °C). Temperatures must be limited to 180 °C or less if there are any viton seals in the system.*

Bakeout Operation Procedure

1. Switch on the heaters.
2. Monitor system pressure until system is heat-soaked and system pressure begins to decline.
3. If bakeout temperatures near 250°C, shut off the ion pump and use an auxiliary pump for bakeout.
4. **DO NOT** cut the bakeout period short. In most cases, a minimum of eight hours is recommended. Longer bakeout periods are often advisable.

NOTE: In a few cases, the ion pump is so badly contaminated that bakeout is not sufficient and it may be necessary to use chemical cleaning, which is a difficult procedure. If this is the case, contact your local service for details.

Section 4: Service

By mail:

Physical Electronics, Inc.
PHI Customer Service, M/S G11
6509 Flying Cloud Drive
Eden Prairie, MN 55344
USA

By e-mail:

service@phi.com

By telephone or fax:

Region	Telephone	Fax
U.S.	1-800-922-4744	1-612-828-6325
Outside U.S.	1-612-828-5831	1-612-828-6325
Japan	81-46-785-6522	81-46-785-4411
Europe	49-89-96275-0	49-89-96275-50



WARNING: Performing any service tasks other than those described in this section without the assistance of PHI Customer Service could result in serious injury, could damage equipment, and may nullify applicable equipment warranties.

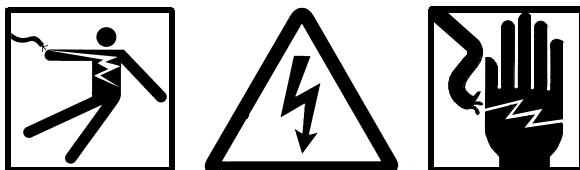

WARNING: Service procedures are for use by qualified and authorized personnel who have experience working with voltages greater than 50 volts. To avoid personal injury, do not perform any installation or service procedures unless qualified to do so.

4: Service

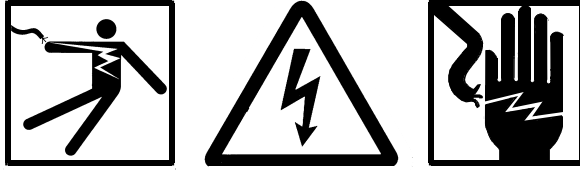

WARNING: Do not disconnect the high voltage cable with power on. After turning power off, allow at least one minute before disconnecting electrical equipment.

The ion pump controller can deliver in excess of 7000V under open-circuit or low-pressure operation: Wait 3 minutes after switching off the ion pump controller before attempting to service it.

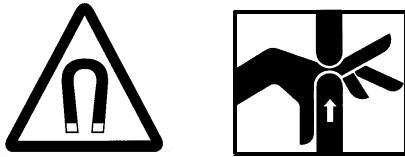

WARNING: Magnetism holding the pole pieces in place is intense. Be very careful with your fingers and hands. Use heavy gloves to avoid injury.

CAUTION:

- Temperatures must be limited to 180 °C or less if there are any viton seals in the system.
- Ferrite ceramic type magnets are easily broken, which reduces the magnetic field. Handle them with care.
- Magnets can destroy mechanical watches and erase magnetic media (such as credit cards or computer disks).
- Temperatures above 350 °C can cause irreversible loss of magnetic field strength. Remove ion pump magnets pump before operating the system at 350 °C or above.



CAUTION: Use standard UHV practices.

- The air and environment you work in must be free of contaminants.
- Hands and gloves must be free from oil.
- Tools and parts must be clean and wrapped in aluminum foil to keep them free of contaminants.

Troubleshooting Ion Pumps

Removal for servicing is to be performed by PHI Customer Service personnel only, according to PHI Customer Service procedures. Tools are to be used on equipment by technicians only, not by operators.*

Table 4-1. Troubleshooting Chart.

Symptom	Cause/Corrective Action
pump does not start	<ol style="list-style-type: none"> 1. Insufficient roughing pressure. Check roughing pump. 2. Leak in roughing system or line. Leak in vacuum chamber, pump, or component (see Section 1). 3. Ion pump contaminated. Determine the source of contamination. Pump may require chemical cleaning. 4. Ion pump contaminated with inert gases. Backfill system with dry nitrogen.
pump gets hot during starting	<ol style="list-style-type: none"> 1. Insufficient roughing pressure. Check roughing pump. 2. Leak in roughing system. Leak in vacuum chamber, pump, or component (see Section 1). 3. High gas loads. Remove materials with high outgassing rate (Section 3).
pump does not reduce system pressure	<ol style="list-style-type: none"> 1. Ion pump is hot. Allow the system to cool to room temperature. 2. Check the ion pump controller for a malfunction (Section 2). 3. Do a resistance check of ion pump elements (Section 4). 4. Test for leak (Section 1). 5. Check for high leakage current (Section 3).
ion pumpdown is slow and base pressure higher than previously	<ol style="list-style-type: none"> 1. Ion pump is hot. Allow the system to cool to room temperature. 2. Atmospheric contaminants in system (Section 3). 3. Test for leaks (Section 1). 4. High gas loads. Remove materials with high outgassing rate (Section 3).
no current even though the meter is showing the correct voltage	<ol style="list-style-type: none"> 1. Check that the polarity of the ion pump controller is correct. 2. Check that the high voltage cable is connected to both the ion pump high voltage feedthrough and the ion pump controller. 3. Be sure that any safety features, such as ground protection relays, are operating properly. 4. Verify that the pressure is within normal operating range (Section 7). 5. Check that the magnets are installed correctly (Section 6). 6. Visually inspect that internal connections between the HV feedthrough and pump elements are intact. Check electrical continuity with a meter.

* “PHI Safety Notices” at the beginning of this document describes who is an operator and who is a technician.

4: Service

Table 4-1. Troubleshooting Chart (continued).

Symptom	Corrective Action
excessive current	<ol style="list-style-type: none"> 1. Test for leak (Section 1). 2. High gas loads. Remove materials with high outgassing rate (Section 3). 3. Check for high leakage current (Section 3). 4. Do a resistance check of ion pump elements (Section 4). 5. Check ion pump controller for a malfunction (Section 2).
current rises to higher level than previously	<ol style="list-style-type: none"> 1. Atmospheric contaminants in system (Section 3). 2. Test for leak (Section 1). 3. Check for high leakage current (Section 3). 4. Hydrocarbon contamination from oil or grease.¹ 5. High vapor pressure materials such as active metals (cesium, rubidium).²
rapid sustained increase in ion pump current	<ol style="list-style-type: none"> 1. Test for leak (Section 1). 2. Hydrocarbon contamination from oil or grease.¹ 3. High vapor pressure materials such as active metals (cesium, rubidium).²
current not proportional to pressure	<ol style="list-style-type: none"> 1. Check for high leakage current (Section 3). 2. Do a resistance check of ion pump elements (Section 4).
noble gas instability indicated by current spikes	<ol style="list-style-type: none"> 1. Re-emission of previously pumped argon (or other heavy noble gas) due to sputtering of the covered over areas. Corrected by: <ol style="list-style-type: none"> a) Test for air leak (section 1). b) Remove the source of the noble gas. If you cannot do this, then reconfigure the ion pump elements to allow stable argon pumping. 2. Buildup of conductive films from sputtering with the pump, extended operation at high pressures, or deposits of conductive contaminants. Clean the outside ceramic of the high voltage feedthrough. If that does not work, a rebuild of the ion pump and its elements is needed.

¹ Hydrocarbon contamination could be caused by an untrapped mechanical or diffusion pump, the residual from machining operations, finger prints, or organic sealing greases.

² High vapor pressure materials may come from an experiment or oven source as part of the process being performed in the vacuum chamber. Excess material may deposit in the cool parts of the vacuum system due to accidents or long term exposure. Such materials may be detected by a metallic sheen on interior of glass parts such as ion gauges. Ion pump needs to be rebuilt and vacuum system interior needs to be thoroughly cleaned.

Section 1. Vacuum Leak Testing

When a leak in an ion-pumped system is probed with a gas such as helium, there is a slight change in the ion pump current. The magnitude of this change is a function of the leak size, other pumps in the system, probe gas, operating pressure, and ion pump history. To perform a leak test with an ion pump controller, use the following procedure.

ATTENTION: An excessive amount of helium in the vacuum system may cause the ion pump to stall since helium pumping speed is less than that of air. Probe large leaks cautiously.

1. Valve off portions of the vacuum system (if possible) until the section containing the leak is isolated.
2. Valve off all pumps except the ion pump (this may not be possible if the gas load is too high).
3. Allow system pressure to stabilize.
4. Connect a digital voltmeter to the analog output for current monitoring.
5. Probe area with helium while watching for a change in the digital voltmeter. Initially, the current drops slightly and then rises as helium is detected.

NOTE: Larger leaks should be probed with methanol in a fine squeeze bottle.

6. Remove the gas once a leak has been identified.
If a leak is present, perform a welded repair.

Section 2. Operation Check of Ion Pump Controller

1. Switch off the ion pump controller.
2. Disconnect the high voltage cable from the ion pump controller.
3. Switch on the ion pump controller.
4. Check the ion pump controller. While disconnected, it should reach full-rated voltage and show zero current if operating correctly.

Section 3. Leakage Current and Field Emission Test

Total current in an ion pump is comprised of a combination of the following four currents:

- Discharge current is the sum of ion flow to/from the cathode plates, which consists of ion collisions with cathode plates and ions liberated from cathode plates. This current is almost proportional to ion pump pressure.
- Secondary electron current occurs when electrons are ejected from cathode plates or ion pump walls by colliding ions. This current increases with increasing ion energy (operating voltage).
- Leakage current flows across a resistive element such as high voltage cable insulation, high voltage feedthrough, or insulating ceramics. This current increases as the ion pump ages when sputtered deposits coat the ceramic insulators with a conductive film.
- Field emission current is caused by a high voltage gradient. This current depends on the voltage, distance to adjacent surfaces, and the geometry of the field emission point. Sharp edges and needle points exhibit higher emission currents since the electric field gradient is greater around them.

To determine whether ion pump current increase is due to an increase in system pressure or leakage current/field emission, follow these steps.

1. Place the system under vacuum sufficient to produce an ion pump current of 1 mA or less.
2. Switch off the ion pump controller.
3. Remove the magnets from the ion pump (see *Removing the Magnets* procedure).
4. Switch on the ion pump controller. Current should be negligible on the ion pump controller at full ion pump controller voltage.
5. If leakage current is present, maintenance may be required.

NOTE: Leakage current causes errors in pump pressure reading, however, it does not necessarily affect actual pumping speed.

Section 4. Resistance Check of Ion Pump Elements



WARNING: Voltages up to 7000V can be present in the Ion Pump Controller. Turn off power and disconnect AC input power cable to the unit.

1. Turn off power and disconnect AC input power cable to the Ion Pump Controller.
2. Remove the high voltage cable from the Ion Pump Controller end.
3. Connect an Ohmmeter between the center conductor of the high voltage cable and the jacket of the ion pump.
The normal condition is an open circuit.
4. If resistance is indicated, pump or pump elements may need to be rebuilt.

Section 5. Bakeout Operation Procedure

During bakeout, monitor system pressure so that it does not exceed 1×10^{-5} . Initially, it may be necessary to switch the heaters off periodically and allow pressure to drop, then switch the heaters back on as the gas load is reduced.



CAUTION: Temperatures above 350 °C can cause irreversible loss of magnetic field strength. Before operating the system at 350 °C or above, remove the ferrite magnets from the ion pump (samarium-cobalt magnets should be removed above 250 °C).

Temperatures must be limited to 180 °C or less if there are any viton seals in the system.

1. Switch on the heaters.
2. Monitor system pressure until system is heat-soaked and system pressure begins to decline.
3. If bakeout temperatures near 250°C, shut off the ion pump and use an auxiliary pump for bakeout.
4. **DO NOT** cut the bakeout period short. most applications require eight hours minimum. Longer bakeout periods are often advisable.

NOTE: If bakeout is not sufficient, it may be necessary to use chemical cleaning., This is a difficult procedure. Contact your local service for details.

Section 6. Magnet Orientation in Ion Pumps

An ion pump must have a magnetic field that exceeds a minimum value and is precisely oriented parallel to the axis of the anode cells. The magnetic field, in conjunction with high voltage applied to the pump, causes electrons inside the anode cells to travel in curved orbits which are smaller than the diameter of the anode cells.

In an ion pump magnet configurations (Figure 4-1), the magnets must be arranged in a magnetic circuit all the way around the pump, that is N-S-N-S-N-S-N-S.....etc. When installing magnets, the magnets tend to pull into the correct circuit configuration and push away if the configuration is incorrect.

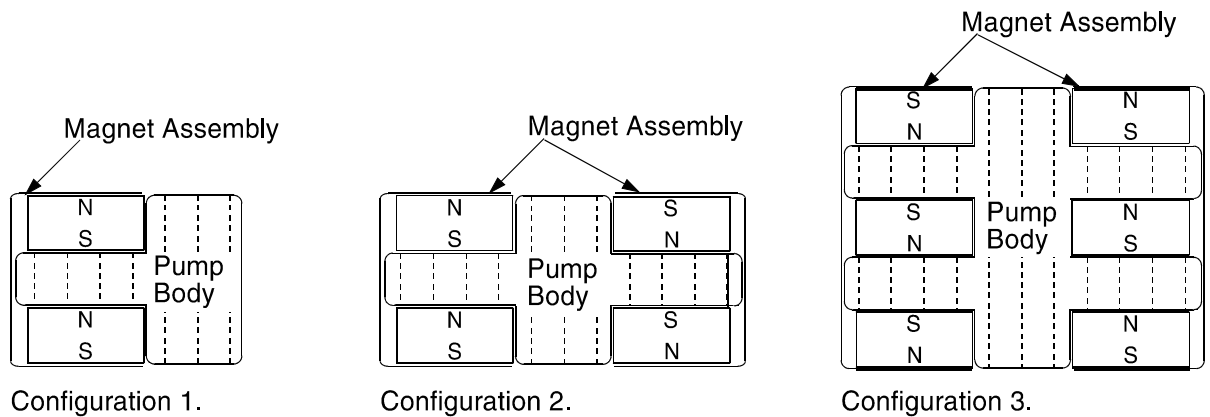

Figure 4-1. Magnet Orientation in Ion Pumps.

In *Configuration 1* above, as long as the individual blocks on the magnet assembly are installed correctly, the orientation of the magnet assembly does not matter.

In *Configuration 2*, the circuit must be completed as shown. If a magnet assembly is installed backwards, the pump operates with some reduction in speed. The stray magnetic field is excessively high and may interfere with sensitive experiments.

Configuration 3 shows the most critical arrangement. If one of the center magnet segments is reversed, pumping speed is reduced by 50%. If the two outside assemblies are reversed with respect to each other, the pump operates with some reduction in speed. The stray magnetic field is excessively high and may interfere with sensitive experiments.

4: Service

Section 7. Operating Pressure

Starting a pump is the process of going from roughing pressures (Zone 2 in Figure 4-2) to the normal operating pressure (Zone 1). In Zone 3, no discharge current occurs. In Zone 4, the current is too low to indicate.

	10^{-8}		10^{-4}	10^{-2}	760
Zone 4	Zone 1			Zone 2	Zone 3

Figure 4-2. Pressure Zones — Torr.

Oxygen Process

Nobel gases can be removed from ion pump elements by introducing oxygen into the system through a leak valve.

NOTE: Ensure that all filaments are shut off while oxygen is being introduced into the system.

1. Shut off all filaments.
2. Adjust oxygen pressure with a leak valve and ion gauge. Bring system pressure up to 2×10^{-5} to 9×10^{-6} .
3. When pressure has been achieved, note the ion pump current and shut off the ion gauge. Use the leak valve to maintain that ion pump current.
4. Let the system pump on oxygen for 12 to 14 hours minimum.

NOTE: Some heating of the ion pump is normal when it is operating at high pressures. Do not allow it to overheat and go into thermal runaway. If overheating cannot be controlled, shut the ion pump off and allow it to cool before re-roughing and restarting.

Disassembling the Ion Pump

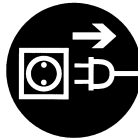

WARNING: Voltages up to 7000V can be present in the Ion Pump Controller. Turn off power and disconnect AC input power cable to the unit.

Before you begin

Before you disassemble the pump, make sure the ion pump controller is off, its power cable is disconnected, and the high-voltage cable is removed from the ion pump side.

Removing HV Feedthrough and Ion Pump Elements

1. Disconnect the feedthrough center post inside the ion pump by removing the connector strap.
2. Remove the hex head screws that fasten the feedthrough flange to the port on the ion pump body.
3. Remove the connector strapping that connects the feedthrough to individual elements.
4. Remove the nuts from the studs that hold the pumping elements in the ion pump body, and remove the elements.

Removing the Magnets

The magnetic field strength should be about 1400 gauss. It can be measured inside the ion pump pocket. Perform the following procedure only if it is necessary, because considerable work is required to remove magnets.

1. Remove the magnet covers.



CAUTION: Before performing the next step, mark the magnets so that you can re-install them in the same orientation. Reversal of magnets severely degrades ion pump performance.

2. Unbolt the pole pieces, where necessary, and slide them along the magnet surfaces. Tilt the pole pieces to remove them from the ion pump.

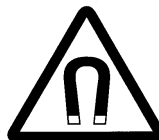
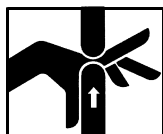

4: Service

WARNING: Magnetism holding pole pieces in place is intense. Be very careful with fingers and hands. Use heavy gloves to avoid injury. Be very careful when handling ion pump magnets around other magnets and ferrous materials.

CAUTION: Magnets can destroy mechanical watches and erase magnetic media (such as credit cards or computer disks).

Handle ferrite ceramic type magnets with care, they can easily be broken.

3. Once pole pieces and magnet covers have been removed, cautiously slide magnets out of their supports.
4. Re-install the magnetism the same orientation. The blocks must be arranged so that the magnetic field is directed in a circular path around the ion pump to complete the magnetic circuit.
5. Check to see if the magnets pull towards each other. If they do, they are installed correctly.

Section 5:

Replacement Parts and Accessories

This section contains the following part numbers for Low Profile Pumps:

- Table 5-1 Replacement Parts and Accessories
- [Table 5-2 Bakeout Heaters](#)

[Ordering Info and Customer Service](#)

To place an order, call 1-800-237-3603. Give the part number and description of the item. For customer Service, call 612-828-6451.

Table 5-1. Replacement Parts and Accessories.

Description	Part Number	
Pump Elements:	DI	Conventional
3x6, 38 cell (6" CFF)	630681	630673
3x6, 38 cell (8" CFF)	630660	630670
High voltage cables (2 Million Series Ion Pumps)		
10'	1001514	
15'	1000438	
20'	1001515	
30'	1001516	
75'	1001517	
50'	1001518	
100'	1006169	
High voltage cables (3 Million Series Ion Pumps):		
3m (10')	642453	
6m (20')	642454	
10 m (30')	642455	
15 m (50')	642456	
20 m (65')	642454	
30 m (100')	642458	
40 m (130')	643506	
50 m (165')	643507	
75 m (245')	643508	
100 m (330')	643509	
High voltage feedthrough:		
PHI	642251	
10 kV	642250	
10 kV w/SAFECONN	639701	
Magnets, 3x6	629524	
DIGITEL™ Small Pump Control (SPC)	647586	
DIGITEL™ MPC Controllers:		
base unit plus 1 medium HV module	635941	
base unit plus 1 large HV module	635942	
base unit plus 2 medium HV modules	635943	
base unit plus 2 large HV modules	635944	
base unit plus 1 medium and 1 large HV module	635945	
Liquid Nitrogen Cryoshroud	1001341	
Ambient Sputter Shield	638146	

5: Replacement Parts and Accessories

Table 5-1. Replacement Parts and Accessories (continued).

Description	Part Number
Flange assembly kits	
mini (1.33 CFF)	2696133
2.75 in. CFF	2696275
blank CFF flange, 3.375 in. CFF	2696377
silver-plated bolts, 4.5 in. CFF	2696450
nut plates and gasket, 6 in. CFF	2696600
8 in. CFF	2696800
Gaskets (10/pkg.):	
1.33 in. OD flange	2680750
2.75 in. OD flange	2681500
3.375 in. OD flange	2682000
4.5 in. OD flange	2682500
6 in. OD flange	2684000
8 in. OD flange	2686000

Table 5-2. Bakeout Heaters for Ion Pumps with Flat Pole Pieces.

Low Profile Ion Pumps	Heater Part Number.		Wattage
	110 Vac	230Vac	
80 to 100 l/s	2190211	2190212	800
160 to 200 l/s	2190431	2190432	1200
240 to 300 l/s	2190731	2190732	1200
320 to 400 l/s	2191031	2191032	2400
480 to 600 l/s	2191331	2191332	2400

Limited Warranty

Except as otherwise provided herein, the Seller warrants to Buyer that the equipment sold hereunder, whether it is new equipment or remanufactured (reconditioned) equipment, is, at the time of shipment to Buyer from Seller, free from defects in material and workmanship. As Buyer's sole exclusive remedy under this warranty Seller agrees either to repair or replace, at Seller's sole option and free of part charge to Buyer, any part or parts of such equipment which, under proper and normal conditions of use prove to be defective within 12 months from the date of receipt by the Buyer. Warranty period for equipment requiring installation by Seller will commence on completion of standard installation services. If customer delays installation beyond 45 days after delivery, the warranty period will commence to run 45 days after delivery. After installation, any realignment, readjustment, recleaning or recalibration, provided it does not relate to a proven defect in material or workmanship, shall be performed only at Seller's then current rates for service.

Exclusions and Limitations

It is recognized that some parts by their nature (expendable items) may not function for one full year; therefore, excluded from the foregoing warranty are filaments, anodes, cathodes, multipliers, retard grids, special ceramics, ionizers, along with other such parts mentioned in the applicable operating manual.

The foregoing warranty excludes certain major items or accessories specifically indicated on applicable price lists or quotations, as to which Seller passes to Buyer whatever warranty is provided to Seller by the manufacturer or the

specific warranty indicated by the price list or quotation.

This warranty does not cover loss, damage, or defects resulting from transportation to the Buyer's facility, improper or inadequate maintenance by Buyer, buyer-supplied software or interfacing, unauthorized modification or misuse, operation outside of the environmental specifications for the equipment or improper site preparation and maintenance.

Product Service

All claims must be brought to the attention of Seller within 30 days of the failure to perform.

Seller at his option may require the product to be returned to the factory, transportation prepaid, for repair.

Refund of Purchase Price

In lieu of the foregoing, Seller may at any time elect, in its sole discretion, to discharge its warranty by accepting the return of such equipment and refunding any portion of the purchase price paid by Buyer.

Software and Firmware Products

The sole exclusive warranty applicable to software and firmware products provided by Seller for use with a processor will be as follows: Seller warrants that such software and firmware will conform to Seller's program manuals current at the time of shipment to Buyer when properly installed on that processor. Seller does not warrant that the operation of the processor software or firmware will be uninterrupted or error free.

No other warranty is expressed or implied. Seller expressly disclaims the implied warranties of merchantability and fitness for a particular purpose.

Customer Service

Order Information

Call the order desk at 1-800-237-3603 or 612-828-6466 (FAX: 612-828-6322). When ordering any item, please give the order number and a description.

Assistance

If you have any questions regarding service, technical questions, or replacement parts, please contact:

Physical Electronics
Customer Service Dept.
6509 Flying Cloud Drive
Eden Prairie, MN 55344

Telephone: 1-612-828-6451 or toll free at 1-800-922-4744
Fax: 1-612-828-6325

Reconditioning

PHI will recondition your ion pump, usually within two weeks of approval. Call the service department to arrange shipment. Factory reconditioning includes:

1. Complete disassembly down to the basic component level.
2. Replacement of the following components:
 - high voltage feedthrough
 - ceramic standoffs
 - ceramic shields
 - pinch-off flange
 - gaskets and hardware
3. Novamax chemical cleaning of all reusable components.
4. Reassembly in a clean room environment.
5. Vacuum leak check.
6. Electrical checkout and start.
7. Bakeout.
8. Base pressure verification and return shipment under vacuum.

Reconditioning is guaranteed to original pumping specifications and carries a 6-month warranty.

Equipment

- The service department sells reconditioned high vacuum equipment. For a list of components and prices, contact the service department.
- Loaner electronic units are issued on a priority basis for customers who experience a unit failure within the warranty period.
- Rental electronic units are issued on a priority basis for customers who want to keep their systems on line during non-warranty repairs.